

---

*EELE 488  
Wildlife  
Tracking  
System*

---

*Kristopher Kenney  
Kostya Kravchenko  
Ryan Maroney  
Gavin Swietnicki*

---

Fall 2014

---

# Contents

<b>1</b>	<b>PROBLEM DEFINITION.....</b>	<b>4</b>
1.1	INTRODUCTION.....	4
1.2	NEEDS DESCRIPTION.....	4
1.3	STAKEHOLDER LIST.....	6
1.4	PROJECT GOALS.....	6
1.5	PROJECT CONSTRAINTS.....	7
<b>2</b>	<b>FUNCTIONAL ANALYSIS.....</b>	<b>8</b>
2.1	INTRODUCTION.....	8
2.2	BLACK BOX MODEL.....	8
2.3	FUNCTIONAL SPECIFICATIONS.....	10
2.4	DESIGN METRICS.....	11
<b>3</b>	<b>ALTERNATIVES EVALUATION.....</b>	<b>13</b>
3.1	INTRODUCTION.....	13
3.2	DESIGN ALTERNATIVES.....	13
3.3	CLIENT/USER OPERATION.....	18
3.4	DECISION MATRIX.....	18
<b>4</b>	<b>PROJECT PLANNING.....</b>	<b>20</b>
4.1	INTRODUCTION.....	20
4.2	RISK ANALYSIS.....	20
4.3	MITIGATION STRATEGY.....	22
4.4	WORK BREAKDOWN STRUCTURE.....	23
4.5	RESPONSIBILITY MATRIX AND PROJECT SCHEDULE.....	24
<b>5</b>	<b>CONCEPT DEVELOPMENT.....</b>	<b>27</b>
5.1	INTRODUCTION.....	27
5.2	CONCEPT DESIGN.....	27
5.3	EVALUATION CRITERIA.....	32

5.4	CONVERGENCE PLAN .....	33
5.5	CONTINGENCY PLAN .....	33
<b>6</b>	<b>SYSTEM ARCHITECTURE .....</b>	<b>35</b>
6.1	INTRODUCTION.....	35
6.2	SYSTEM ARCHITECTURE PLAN .....	35
6.3	SYSTEM INTERFACES .....	39
6.4	SUB-SYSTEM INTERFACES .....	41
6.5	USER INTERFACES.....	43
<b>7</b>	<b>DETAILED DESIGN .....</b>	<b>45</b>
7.1	INTRODUCTION.....	45
7.2	LAYOUT DRAWINGS.....	45
7.3	BILL OF MATERIALS .....	50
7.4	PURCHASED COMPONENT SPECIFICATIONS.....	51
7.5	DETAILED DESIGN .....	55
7.5.1	<i>Calculations</i> .....	55
7.5.2	<i>System Model</i> .....	61
7.5.3	<i>Safety Considerations</i> .....	61
7.6	PRODUCT LIFECYCLE .....	62
<b>8</b>	<b>REFERENCES.....</b>	<b>64</b>

# **1 PROBLEM DEFINITION**

## **1.1 Introduction**

Wildlife monitoring is an essential tool in the arsenal of ecologists and biologists around the world. It is very useful for learning more about wild animals by keeping track of their movement patterns, habitat and demographics.

Current animal tracking method involves a collar with an RF (radio frequency) transmitter that is put on the animal and a RF receiver. In conjunction with a directional H-antenna, the direction the signal is coming from can be captured and the location coordinates of the animal can be deduced. However very economical, this method suffers from limited signal detection range of about 2 km (1.25 miles) on the ground, which is crucial in wildlife habitats that may cover thousands of square miles. This range can be greatly increased by the use of a conventional aircraft, however it is very expensive and not always easy to coordinate.

This project builds upon discussed methods and introduces a middle ground between price and detection range. It involves using a drone, with attached radio equipment, as a link between the tracked animal and the researcher on the ground. Scott Creel from the ecology department of MSU has a prototype system discussed above; however it does not work as intended.

The goal of this project is to remove the design flaws that are preventing proper operation and to design a new system that will build upon the current design to meet the needs of the client.

## **1.2 Needs Description**

The purpose of this project is to find a solution to eliminate interference of information gathered by a directional antenna picking up VHF signals sent to the ground by a 5.8 GHz link, as well as to create a system that can receive VHF signals under typical field conditions from a range altitudes of at 300-3000 feet.

The Product is comprised of a remote-controlled quad-copter drone capable of carrying a VHF (very high frequency) receiver, directional antenna, GoPro camera, and a 5.8 GHz transmitter. The antenna is intended to pick up a VHF transmitter attached to a collar of a wild animal. The collar consists of an omni-directional transmitting antenna that relays a VHF "beep" on a specific frequency every 1.2 seconds when the animal is moving, and every 2 seconds when the animal is still. The intended purpose of this product is to be able to hover to an altitude to gain a bearing and direction of a collared animal through the signal gained on the directional antenna. The increase in altitude results in the VHF receiver's ability to pick up the transmitting collar from farther away than if the receiver was on the ground. The transmitter is able to relay the audio and video signal recorded by the quad-copter to the ground on a 5.8 GHz relay that is commercially available. Generally, this information is gathered on a conventional aircraft that is expensive to rent, whereas the quad-copter is inexpensive to fly and also obtains similar information.

It is essential for this information to be gathered through VHF, because of cost-effectiveness. There is a collar that uses GPS (ground positioning system), however they cost thousands of dollars and have a shorter operation life and have been used for more specific information regarding an animal's behavior. If information is required on a much broader scale where numerous collars are needed, it is more cost effective to relay the information through VHF frequencies.

This product has not been achieved or used commercially because of undiscovered sources of interference which causes the signal from the antenna to be degraded. It is suspected by the client that the source of interference is a result of the quad-copters' GPS assisted flight stabilization system. This system is used to keep the quad-copter in the user's intended position through unpredictable conditions (i.e., a gust of wind). This theory was derived from previous testing done on the quad-copter system. The client has stated that the system has no interference when the quad-copter is at rest however when the quad-copters' GPS assisted flight stabilization system begins to operate, the interference initiates. The project's main concern is eliminating this interference.

### 1.3 Stakeholder List

Ecologists, biologists, researchers and people that are generally interested in wildlife would benefit from this project. Increasing the tracking range can potentially save countless hours of driving through the wilderness, gas, personnel money and improved efficiency of collecting data. This will allow researchers to focus more on data analysis instead of data collection. In particular the success of this project will benefit our client, Scott Creel, and the Montana State University Ecology Department. The design would immediately be put into use by the Ecology Department on various projects.

### 1.4 Project Goals

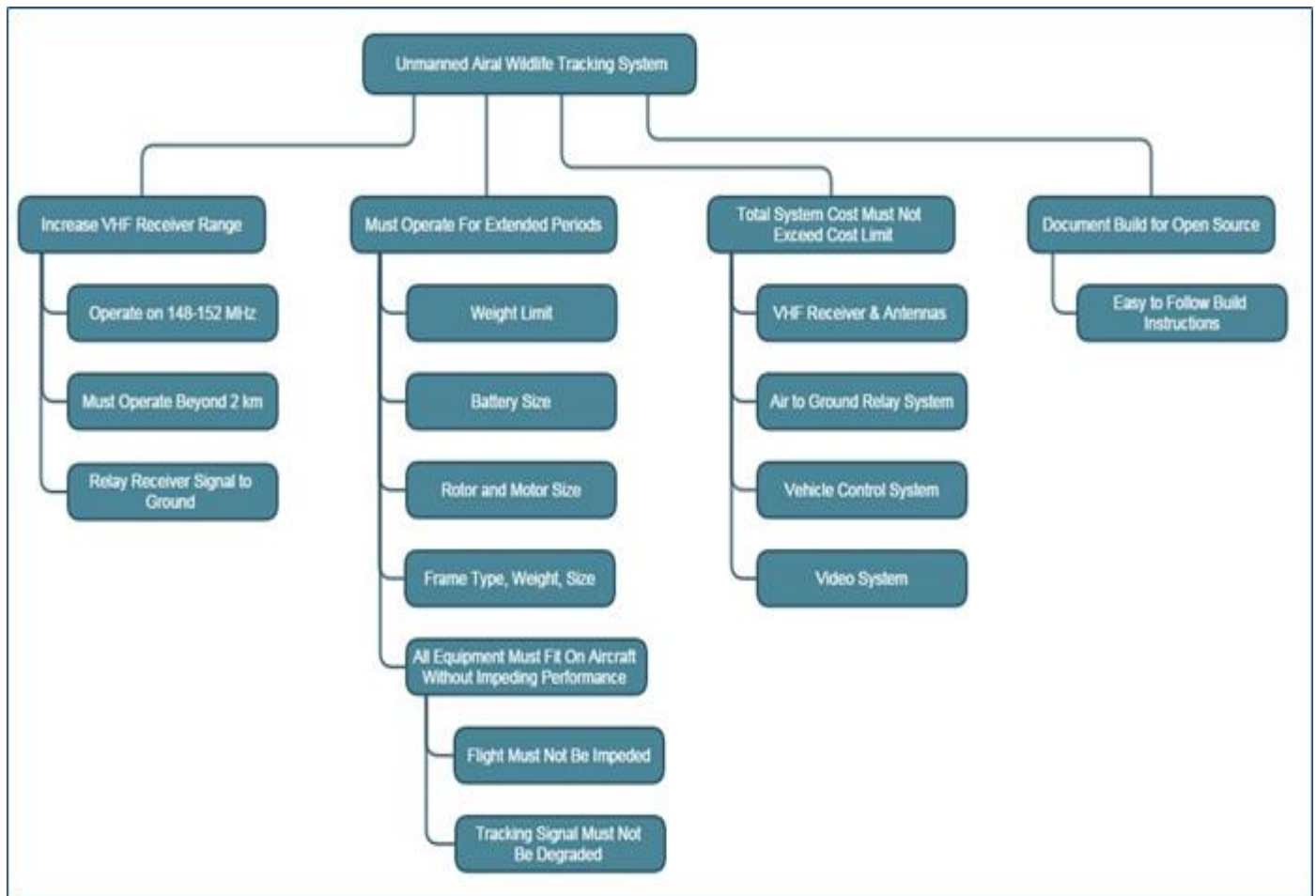

Figure 1.1: Objective tree which demonstrates the functional requirements of the project.

## 1.5 Project Constraints

- Must Operate in a VHF frequency Bandwidth
  - Ideally, the design will use the same VHF frequencies as are currently in use (148-152 MHz)
- Must Minimize Power Consumption for Sustained Flight
  - Power for the design must be provided with battery(s) mounted on the quadcopter
- Must be Equal or Surpass Current Land-Based Signal Detection Range
  - Ideally the design should achieve greater than 2km signal detection range
- Must Minimize Weight and Maximize Flight Time
  - Any weight must be within the limits of the quadcopter's loading capacity (5kg)
  - Weight to power ratio must allow for 30min or above flight time
- Must Contain Entire System on a Small Platform
  - All components must be small enough to fit on the quadcopter
- Must Remain Within Designated Budget
  - The price of the project must be approved/within the budget of the Ecology Department (\$6,000)
- Work in Conjunction with Existing Collars Parameters
  - Design must ultimately work with the existing collars already in use
- Documentation For Open Source Community
  - System must have documentation that can be easily understood by an audience of non-technical personal which outlines build and operation instructions

## 2 FUNCTIONAL ANALYSIS

### 2.1 Introduction

The Functional Analysis section of this report will include a black box model, functional specifications, and design metrics. The Black Box Model containing the input, output, and transfer characteristics will be portrayed. Each input of the Black Box Model will contain a list of items explaining the inputs and outputs of the system. The Functional Specifications will be described to answer what the system does functionally. Each main function will be broken down into sub-functions to provide a better understanding of what the design will accomplish. Lastly, the Functional Specifications will contain the Design Metrics to numerically score the design. A bulleted list of scoring criteria with definitions and units of measure will be provided.

### 2.2 Black Box Model

Figure 2.1 shows the back box representation of the wildlife tracking system project. This is a simple way to view a complex system in terms of just the inputs and outputs and is implemented to aid in the design process by allowing the team to easily determine the overall operation of a complex system.

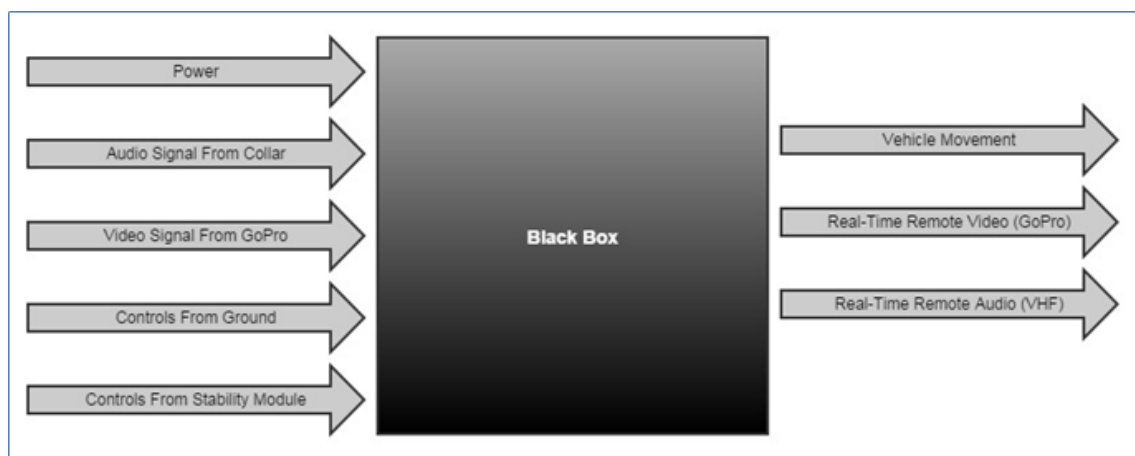

Figure 2.1: Black Box representation of the wildlife tracking system.



### Inputs:

- Audio Signal
  - There will be an input from the VHF antennas which will be the pulse that is sent from the collar that is being tracked
- Video Signal
  - The GoPro camera that is mounted to the base of the vehicle will provide a video input signal to the system
- Vehicle controls to include flight stabilized control module (GPS included)
  - Primary control method will come from the remote control unit
  - Secondary control will come from the control module in conjunction with a GPS
- Power
  - Power for VHF antenna
  - Power for video/audio signal relay
  - Power for vehicle
  - Power for camera

### Outputs:

- Movement
  - Thrust (up-down)
  - Pitch (forward-back)
  - Roll (left-right)
  - Yaw (rotational)
- GHz video (GoPro) relay to ground
  - Video will be relayed to ground control unit so that the pilot may see forward terrain and obstacles
- GHz audio (VHF signal) relay to ground
  - Audio will be relayed to the ground so that the pilot may zero in on the position of the collar being tracked

## 2.3 Functional Specifications

The ultimate goal of this design is to find the distance and bearing to a specific collared-animal being tracked in the field. All components and subsystems of the design simply aid in this overlying goal. A quad-copter has been chosen by the MSU Ecology Department as a tool to help locate the collared-animals in the field. The user will control this quad-copter from the ground through the use of a remote control, bringing it up into flight. The user will move the quad-copter until a ping is heard, indicating that the direction of the animal has been located. Once the direction and distance to the animal have been established, the user can proceed with spotting and observing the animal as needed. The purpose of the design has been achieved, and the animal can be researched.

In order to complete the process leading up to the animal being located, several functions must first take place. Through the use of a directional antenna mounted on the quad-copter, the direction of the collared-animal can be established by rotating the quad-copter in the air (using the remote control). The directional antenna must pick up the frequency being transmitted by the collar on the animal, which is generally between 148-152 MHz. A separate transmitter (mounted on the quad-copter) will then relay a "pinging" noise back to the user on the ground when the directional antenna is oriented in the direction of the collared-animal. This "pinging" noise will be transmitted on a separate (5.8 GHz) frequency to the user on the ground. Once the user hears the noise, the quad-copter can be stopped and the exact direction of the animal can be determined through some fine-tuning of the angle of the quad-copter. The noise will get louder and more distinct as the exact orientation of the directional antenna is found with respect to the collar.

Several other sub-functions will also be in play during the flight process. In addition to the "pinging" noise, there will be a real time video feed being transmitted from the quad-copter to the user on the ground. This will also transmit over the 5.8 GHz link, and will convey video being taken from a GoPro mounted on the quad-copter. This video will aid in providing a visual for the pilot orientation for the quad-copter while in the air. The video will be displayed on a screen mounted to the remote control on the ground. Another

sub-function is the flight stabilization system used by the quad-copter. This system uses a GPS function and allows the quad-copter to automatically adjust for wind and other outside forces, keeping the drone stable during flight. The final sub-function is the remote control unit itself. As mentioned earlier, this is how the user controls the quad-copter. The user will have this unit in hand while the quad-copter is in flight, allowing for complete control of all movement. All of these functions and sub-functions must be achieved without interfering with each other, which is the flaw found in other prototypes and has prevented the design from being a successfully implemented in the field.

## 2.4 Design Metrics

The availability of design metrics in the early stages of design development process will allow better management and flow of later phases. More effective quality assessment of the design alternatives will be achieved by evaluating criteria in the decision matrix. The design matrices are defined in a way that will be the most meaningful to the project. This will allow for better understanding of the design constraints and easier evaluation of the quadcopter alternatives. The matrices are based on high level functional and qualitative requirements, which include: ease of use, portability, durability, safety, affordability, functionality. All of these requirements are of the utmost importance to our client. However our client's biggest concern is functionality of the tracking systems when used in conjunction with the various subsystems in at operational environment: range of the signal detection, flight time, interference and noise rejection. These constraints will be prioritized during the decision making process.

- Easy-to-use
  - Comparable to current system quadcopter setup
  - Easy to tune radio equipment and antennas
- Weight
  - Quadcopter (QC) weight w/ payload and batteries under 5[kg]
- Altitude and range
  - Audio signal range 2-10 [km]

- Sufficient altitude to provide range and QC to remain operational 100-1000 [m]
- Flight time
  - 30+ [min]
- Durability
  - Overall system does not impede the QC functionality and create flight problems
  - System allows for sufficient flight time
  - Operational at high temperatures >45 [C]
- Safety
  - System does not radiate harmful RF
- Cost
  - Under \$6,000
- Portability
  - Complete system can fit into a car or can be assembled at the deployment location
- Signal reception
  - Audio signal is more clear than in the current system (better Signal to Interference and Noise Ratio 'SINR')
  - Minimum detectable VHF signal from the collar -150[dBm]
  - GPS flight control system works as in the current system
  - Video/Audio feed works as in the current system
  - Allows control of the VHF receiver from ground, which allows scanning for multiple collars remotely

### 3 ALTERNATIVES EVALUATION

#### 3.1 Introduction

The Alternatives Evaluation of this report describes the alternatives of the design that will accomplish the functionality of what is intended. Here, three designs will be explained with a decision matrix that weighs design metrics to decide on the most sensible design. Client/User operation will also be explained. This will consist of an explanation of how the user will interface and operate the product.

#### 3.2 Design Alternatives

##### 1) Quadcopter Solution

Table 3.1: Marked in green are the options that were chosen for design one.

Quad-copter	1	2	3	4	5	6
Collar/Receiver	VHF	GPS	IR	UHF	Bluetooth	
Relay	Wi-Fi	IR	VHF	UHF	SHF	
Vehicle	Quad-copter	Hexa-copter	RC Airplane	Balloon	Piloted Aircraft	Octo-copter
Remote Control	Handheld Tx	Truck-mount Tx				
Video	HiDef	LowDef	Still shot			Satellite PC
Antenna	Omni	Directional	Dipole			
Power	Solar	Solid State Battery	Fission	Fusion	Fuel Cell	

This design draws influences from multiple ideas and combines them together to get the best of several worlds. The vehicle of choice is the quadcopter, chosen as a cheap, easy, and reusable way to get a directional antenna in the air for better range. The quadcopter offers a much less expensive option when compared to an airplane ride, and is also much more durable, faster, and easier to use than a balloon option. The collar and receiver would use VHF frequency, which is more common and is something the ecology department is already familiar with. The relay would use SHF as the frequency, incorporating a 5.8GHz frequency available for industrial, scientific and medical (ISM) purposes. The quadcopter would utilize a handheld remote control operated by the user on the ground. The video feed from the GoPro camera would be in high definition. There is really no reason to not incorporate HD video given the opportunity and small price difference. A directional antenna would be mounted on the quadcopter, in order to pinpoint the location of the collared animal. This is really the only option for an antenna in this design. As for power, a solid state battery would provide the best solution for the quadcopter and the subsystems. A battery is reliable, cheap, and able to provide constant power when compared to other options. Overall, this design certainly provides the best option, and will be used unless unforeseen issues cannot be overcome.

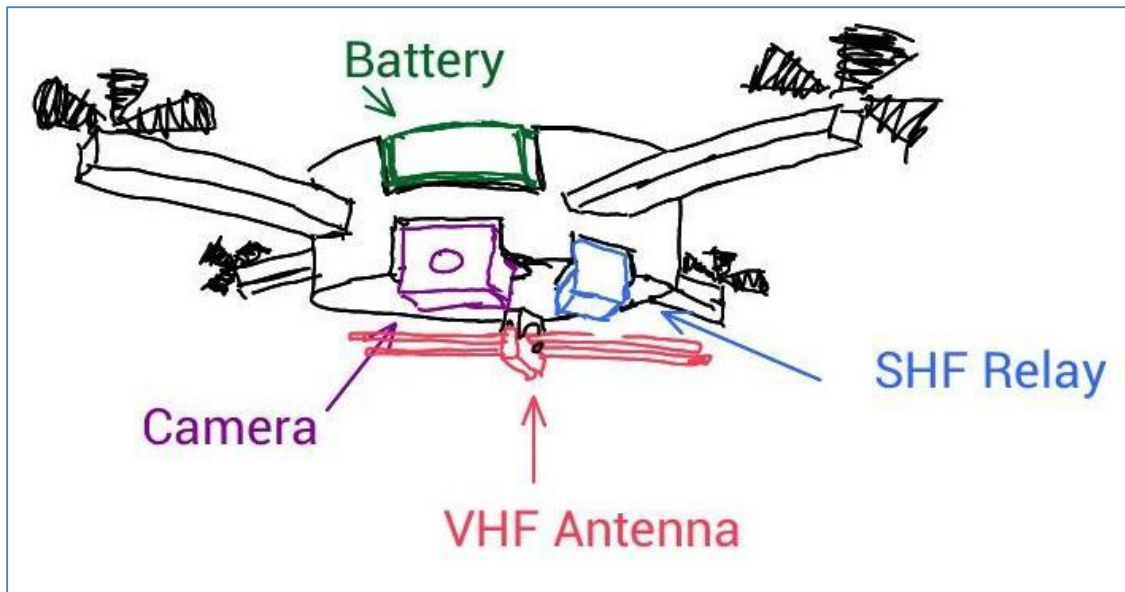

Figure 3.1: Sketch of quadcopter with all of the required components.

## 2) Stripped-down Quadcopter

Table 3.2: Marked in orange are the options that were chosen for design two.

Stripped-down Quadcopter	1	2	3	4	5	6
Collar/Receiver	VHF	GPS	IR	UHF	Bluetooth	
Relay	Wi-Fi	IR	VHF	UHF	SHF	
Vehicle	Quadcopter	Hexacopter	RC Airplane	Balloon	Piloted Aircraft	Octocopter
Remote Control	Handheld Tx	Truck-mount Tx				
Video	HiDef	LowDef	Still shot	none		
Antenna	Omni	Directional	Dipole			
Power	Solar	Solid State Battery	Fission	Fusion	Fuel Cell	

This solution consists of the same main components that were chosen in design 1. The difference in this design is that only the absolutely essential components would be included. The GoPro video would be taken off of the quadcopter. The client has expressed that this option is not essential, and can be removed if deemed unnecessary or found to be interfering with the main audio signal. Any stabilization system included on the quadcopter could also be removed in this design option. The reason for this would be if the stabilization system was found to be an interfering device. This would make the quadcopter slightly harder to control and use, but the end goal could still be achieved. The quadcopter could still be taken up into flight to find the location and bearing to an animal. In short, this design solution would consist of removing any unnecessary components if they were found to be a hinder to the overall system. Only the bare essential parts required to achieve the level one requirements would remain.

### 3) Balloon Solution

Table 3.3: Marked in blue are the options that were chosen for design three.

Balloon Solution	1	2	3	4	5	6	7
Collar/Receiver	VHF	GPS	IR	UHF	Bluetooth		
Relay	Wi-Fi	IR	VHF	UHF	SHF	Cable	
Vehicle	Quad-copter	Hexa-copter	RC Airplane	Balloon	Piloted Aircraft	Octo-copter	
Remote Control	Handheld Tx	Truck-mount Tx	Tether				
Video	HiDef	LowDef	Still shot				Satellite PC
Antenna	Omni	Directional	Dipole				
Power	Solar	Solid State Battery	Fission	Fusion	Fuel Cell	Cable	

The Balloon Solution design was constructed entirely for the purpose of cost effectiveness and elimination of noise between the components used. However, there are multiple flaws that come with using a simple design as this. The vehicle used would be a balloon that would carry the weight of the devices explained. The collar uses VHF, which is commonly preferred and is already used by the Ecology Department. The relay from the balloon to the ground would use a hard wire instead of a GHz link to eliminate noise and create an improved signal to the user. To control the vehicle, a tether would be used. The tether is not ideal, but is certainly cost effective. The video will be gathered by a GoPro on the balloon. The video will be HiDef since resources



that could be used elsewhere (i.e. GHz link, Quadcopter Drone, or manned aircraft) can be used for video capture. The antennas used on this design would be three directional antennas organized radially around the balloon. Since the balloon cannot be controlled, the bearing to the collar would have to be gathered by recognizing which antenna picks up the strongest signal. Lastly, to power the design, a cable from the ground will be used to power the components. Indubitably, the largest flaw of this design comes from the factor of cost effectiveness. This design is not durable or easily operated in non-ideal weather conditions. This design would best be used as a critical last resort. If other designs become too expensive, or noise cannot be overcome, then this design can be considered and improved upon.

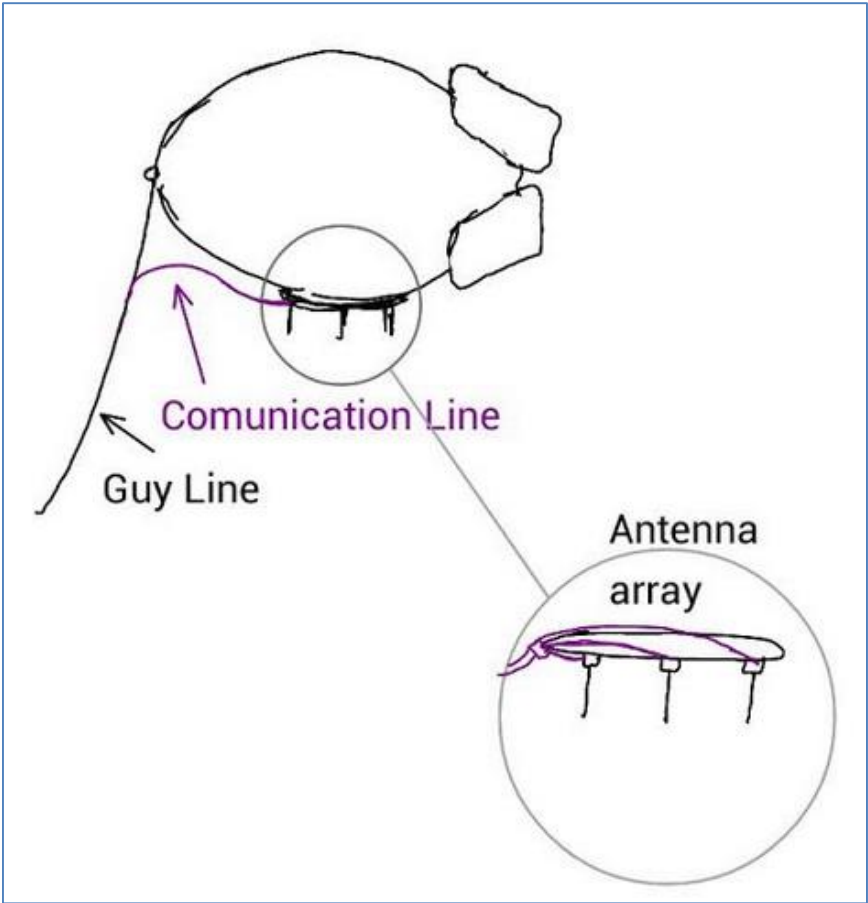

Figure 3.2: Sketch of balloon with antennas and ground tether.

### **3.3 Client/User Operation**

Design one will be chosen because it best meets the client requirements which can be seen in the decision matrix below. The way this design will be implemented will be to fly the quadcopter from the ground. The signal will be relayed from the animal collar to the VHS antenna through the SHF relay to the ground operator. This will require the quadcopter to be portable which means that it must be assembled and disassembled in the field to increase portability. Once the quadcopter is in the field, assembled and ready to deploy, the user will need to turn on all of the components and test operation before lifting off the ground. This will involve ensuring batteries have sufficient charge for operation of each device and ensuring that all devices are working together. Once a ground test has been completed by ensuring the video and audio are being transmitted by the SHF relay, the quadcopter controls must be checked at low altitude. This can be done by slowly raising the vehicle off of the ground using lift via the remote control. Once lift has been established, yaw, pitch and roll can be tested. Once all flight controls are confirmed operational the device may be lifted to operational height and a 360 degree yaw (spin a full circle) will determine if a collar is in range. If a blip is heard via the SHF relay, the pilot will yaw left and right until the direction is determined. Once the direction is determined, then the lift may be adjusted to establish a distance. Using these two parameters, distance and direction, the researcher has the information they need to find the animals for research.

### **3.4 Decision Matrix**

A decision matrix is a tool that is applied in an engineering design process and is used to select the most feasible project design. The idea is to score each design alternative across the design metrics discussed previously. Obviously every metric has a different importance factor which is determined based on the design goals. To account for this factor a weight system is used. Each design objective/metric is scored on a scale from 1 to 10. This determines the weight/importance of the metric. After the three alternatives are scored across each metric and using a formula that accounts for the weights, a total score is produced. For this project: cost-effectiveness, operational range and bearing accuracy were chosen to be the most crucial to the success of the design and received scores 9 to 10. Due to the quadcopter design scoring the most in

these categories, this design got the highest overall score and was chosen to be the best solution.

*Table 3.4: Decision Matrix showing the scores of each selected design.*

Objective	Importance Score	Weight(%)	Quadcopter	Stripped-down Quad	Balloon Solution
Cost Effective	10	18.52	10	10	10
Durable	6	11.11	5	4	4
Flight time	3	5.56	5	5	7
Ease of Use	2	3.70	8	6	6
Safety	1	1.85	8	8	8
Range	9	16.67	8	8	8
Weight	3	5.56	8	9	5
Portability	5	9.26	9	9	6
Signal Interference/Noise	5	9.26	5	7	9
Bearing Accuracy	10	18.52	9	8	6
<b>Total</b>	<b>54</b>	<b>100.00</b>	<b>7.87</b>	<b>7.74</b>	<b>7.16</b>

## 4 PROJECT PLANNING

### 4.1 Introduction

In the project planning stage, a risk analysis, mitigation strategy, work breakdown structure, responsibility matrix, and project schedule will be constructed and explained. The risk analysis will contain an evaluation of all the potential risks in the design. The potential risks are rated by the severity of the risk potential, and the probability if it occurring. A chart will depict these metrics as well as a description of each risk. The mitigation strategy will contain a plan to resolve the risks that were placed above the threshold line in the risk analysis. The work breakdown structure will contain high level tasks that require work for the project to be completed. The responsibility matrix consists of a list of what areas of the project are being covered by each member of the group. Lastly, the project schedule is shown in the form of a Gantt chart. Both the responsibility matrix and project schedule are shown in the Gantt chart.

### 4.2 Risk Analysis

#### **Unable to test existing equipment:**

Due to currents parts being in Africa until November, there is a chance these will not get to be tested as planned. This would be due to unforeseen and uncontrollable events with logistics. The group would not be able to perform tests on the components that the Ecology Department already has and would have to pick components based solely on research.

#### **Unable to obtain a particular part:**

After picking all necessary components for the design, it is possible that a particular part may not be obtainable. The part may be too expensive, take too long to manufacture or ship, or may no longer be in production.

#### **Inadequate component:**

It is possible that a part may be ordered and tested, and it is then found that the part will not work as intended in the design. The component may have a hardware defect, differ from its datasheet specifications, or fail to perform as theoretically predicted.

**Design has too much interference:**

This would occur if the components chosen for the design were not completely compatible with each other. There would be too much noise in the system for the signals to be audible for the user on the ground. Possible sources of this noise could include the Go Pro, the GPS flight stabilization system on the quadcopter, the power source, or the receiver/transmitter subsystem.

**Design is unsafe:**

After building a new prototype and testing it, there is a chance that the group could deem it unsafe. This could be due to harmful frequencies being emitted or the quadcopter being dangerous for the user to operate.

**Drone laws change in the United States:**

There is a potential that laws may change in United States at some point in the design relating to civilian drone usage. Depending on the severity of the law change, the sponsor would have to be notified and an alternative design may have to be implemented.

*Table 4.1: Evaluating the Potential Risks*

<b>Risk</b>	<b>Severity of Risk*</b>	<b>Probability of Risk*</b>	<b>Total**</b>
<b>Unable to test existing equipment</b>	3	3	6
<b>Unable to obtain a particular part</b>	4	2	6
<b>Inadequate Component</b>	7	1	8
<b>Design has too much interference</b>	9	6	15
<b>Design is unsafe</b>	8	1	9
<b>Drone laws change in USA</b>	5	3	10
*Each risk rated on a scale of 1-10.			
**Threshold establish as a 5, all risks are above this threshold.			

### 4.3 Mitigation Strategy

**Risk:** Unable to test existing equipment

**Mitigation Strategy:** Empirical work would need to be performed both for the old and new design. Components may have to be selected solely based on calculations and research, without testing the old parts. A meeting would be set up with the sponsor to see if the group could get ahold of similar equipment or at least individual components for testing.

**Risk:** Unable to obtain a particular part

**Mitigation Strategy:** An alternative part or manufacturer would need to be found. It must be confirmed that the new solution achieves similar performance. If said part is not critical, consider removing it from the design.

**Risk:** Inadequate component

**Mitigation Strategy:** If the component contains a hardware defect or does not perform as advertised, request a replacement from the vendor. As a last resort, replace the component with an alternative, or completely remove if it is not critical to the project success.

**Risk:** Design has too much interference

**Mitigation Strategy:** Interference can be mitigated through theoretical work and existing prototype testing. If it is not prevented with these methods, troubleshooting and component testing will be conducted on final design. The interfering component(s) will then need to be replaced accordingly.

**Risk:** Design is unsafe

**Mitigation Strategy:** Apply safety measures based on the type of unsafe performance. Use shielding for excessive RF radiation, sound dampeners in case of excessive noise footprint, shielding around dangerous moving parts, etc.

**Risk:** Drone laws change in the United States

**Mitigation Strategy:** Consult with the sponsor on whether the law change critically affects his research or this project. If it does, propose switching to

the Balloon design or modifying the quadcopter solution to be in accordance with new law.

#### 4.4 Work Breakdown Structure

- **Research Existing Hardware:** The components that make up the current design will be researched. Research will pertain to understanding the current hardware to compare to other possibilities. Sources of interference can be gathered from looking into the specific hardware.
  - SHF Relay
  - VHF Antenna assembly
  - Quadcopter assembly
  - Go Pro/Camera Stabilizer
  - VHF Collar
- **Research Ways to Isolate Electromagnetic Interference:** In a scenario where it is not possible to contain the interference between these components, an alternate solution can be implemented.
- **Contact Hardware Suppliers:** Inquire about any known existing sources of interference caused by these devices. This step can also be used for recommendations or whether a solution has been created to resolve the potential issues.
  - Hardware suppliers from existing prototype.
  - Potential hardware suppliers from researching components.
- **Finalize Hardware:** The hardware will be decided upon based on previous research. Ideally, the parts will be chosen to eliminate the source of interference. Final hardware will strive to be the best variation in regards to cost-effectiveness and efficient execution of the purpose; to transmit a signal received by the antenna to the user.
- **Test Existing Prototype:** The prototype currently being used will be tested to observe the behavior of the interference. Multiple tests will be done on each individual component to gain a better bearing on the source of interference. With the research done prior, the developed background on each device will enable the group to construct a well backed hypothesis of the source of interference.
- **Order Parts**
- **Build New Prototype:** From the components ordered, a new prototype will be constructed based on the prior research and what was found through testing the existing prototype with the problematic interference.
- **Troubleshoot Design:** The new prototype will require troubleshooting to observe unexpected behavior. In this stage, possible errors in the behavior

will be found and solved (i.e. still contains interference, signal not coming through loud enough). The design will be improved upon based on what is found in this step.

## 4.5 Responsibility Matrix and Project Schedule

\*Color Key:

Kristopher	Quad-copter Controller
Chris	VHF Antenna/Receiver
Gavin	SHF Relay
Ryan	GoPro Stabilizing Mount
All	

\*See next two pages for schedule.







## **5 CONCEPT DEVELOPMENT**

### **5.1 Introduction**

In this section, the winning concept design is explained in detail. This is the design that scored highest in the decision matrix. All the components of this design are described and illustrated. Several possible specific parts and manufacturers of these components are also specified. Sketches and pictures are also included to aid in understanding of the design. In addition to this winning design, an alternative is also discussed in the contingency plan. This is a backup solution in the event that the primary design fails. Potential customers of this design have also been identified in this section and interviewed by the team. These customers have provided input on the selected design and any changes that could make the solution better. The feedback has been evaluated in the convergence plan and any differences or suggestions from the interviews are resolved here.

### **5.2 Concept Design**

The Quadcopter was deemed to be the best design option. This was gathered by the decision matrix, which evaluated several designs to achieve similar purposes. The design is comprised of a remote-controlled quad-copter drone capable of carrying a VHF (very high frequency) receiver, directional antenna, GoPro camera, and a 5.8 GHz transmitter. The antenna is intended to pick up a VHF transmitter attached to a collar of a wild animal. The collar consists of an omni-directional transmitting antenna that relays a VHF "beep" on a specific frequency every 1.2 seconds when the animal is moving, and every 2 seconds when the animal is still. The intended purpose of this product is to be able to hover to at altitude to gain a bearing and direction of a collared animal through the signal gained on the directional antenna. The increase in altitude results in the VHF receiver's ability to pick up the transmitting collar from farther away than if the receiver was on the ground. The transmitter is able to relay the audio and video signal recorded by the quadcopter to the ground on a 5.8 GHz relay that is commercially available. Generally, this information is gathered on a conventional aircraft that is expensive to rent, whereas the

quadcopter is inexpensive to fly and also obtains similar information. In this description, each component being used currently will be described in detail along with a basic illustration of what the product looks like.

A potential quadcopter model is a Turbo Ace Matrix S-FPV. This quadcopter is able to achieve a flight time of 25 to 40 minutes without the components added. It is made of triple deck carbon fiber which supports a 1000mm wingspan. On the quadcopter there is a GoPro Hero3 stabilized by a gimbal. The battery is an 8000mA 6S battery. To control the drone, a transmitter operating in the 2.4GHz range is used. There are 4 channels for piloting controls, 2 channels for GPS, and 1 channel for the gimbal stabilization of the GoPro camera. This is typical for advanced quadcopters. The quadcopter uses a NAZA flight controller. This controller allows the user to not have to compensate for wind when controlling the drone. For example, the drone will automatically stable itself when an unexpected gust of wind occurs. Therefore, the user only has to worry about altitude and direction. (Information for the quadcopter came from turboace.com Matrix S-FPV overview).

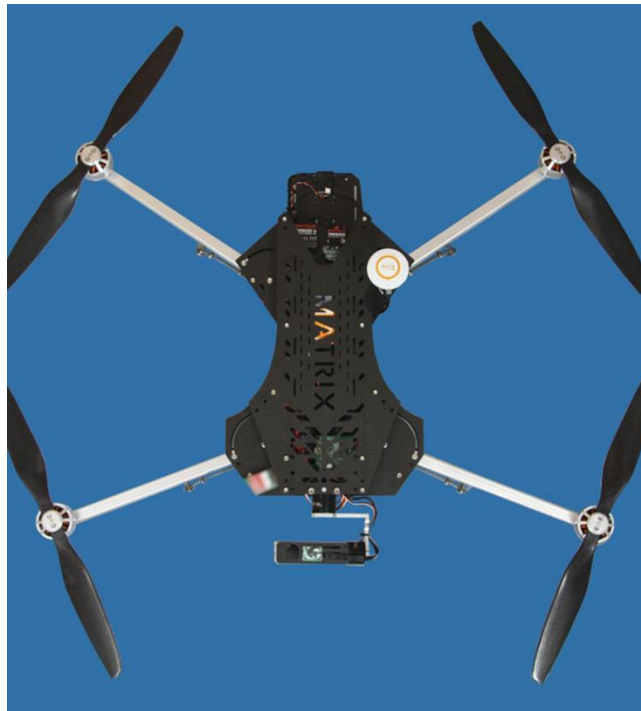

*Figure 5.1: The Matrix S-FPV. Gathered from the Turbo Ace website.*

The GoPro Hero3 records video and audio in a high-resolution, high-frame rate of 1440p48, 1080p60, 960p100, and 720p120. As stated above, it is stabilized by a gimbal attached to the quadcopter. This particular GoPro has WiFi in order to be remotely controlled from a distance.



*Figure 5.2: The GoPro Hero3. Gathered from the GoPro website.*

The transmitter is what relays the signal picked up from the relay and the GoPro to the user on the ground. One possibility for a transmitter is an ImmersionRC 600mW 5.8GHz A/V transmitter. It weighs 18g, which is ideal since weight is influential in the flight time of the quadcopter. It can transmit high-definition video and audio. It is a popular choice by design because of its compatibility with R/C gear which generally operates in the 2.4 GHz range. Typical power consumption of the transmitter comes to 3W. (Information gathered from the ImmersionRC website)



*Figure 5.3: The ImmersionRC 600mW 5.8GHz A/V transmitter. Gathered from the ImmersionRC website*

The 5.8GHz transmitter will relay the signal from the quadcopter to the user on the ground. This signal will be picked up by a receiver such as the ImmersionRC DUO5800 V3 Diversity Receiver. This receiver is compatible with omni and directional antennas that are used to pick up signals in the 5.8 GHz frequency spectrum. The inputs are filtered to isolate the receiver from signals in the 2.4 GHz range.



*Figure 5.4: The ImmersionRC Duo 5800 V3 A/V Diversity Receiver. Gathered from the ImmersionRC website.*

The VHF collar that will be on the animal is a Telonics VHF transmitter. The collars contain a mortality sensing function, two configurable power levels to vary the range or life of the battery, and duty cycling to extend the battery life. They operate in the spectrum of 140MHz to 220MHz where an audible “beep” will be transmitted to the receiver. (Information gathered from the Telonics website)



*Figure 5.5: Five models of the Telonics VHF transmitting Collars. Gathered from the Telonics website.*

The receiver that picks up the “beep” from the collars is generally a Communications Specialists R-1000 Telemetry receiver. It contains a frequency range of 148MHz to 174MHz and 216MHz to 222MHz. Is able to perform a scan sequence to search frequency range of incoming signals. The audio from the receiver will be connected to the ImmersionRC transmitter so that the user on ground can hear the signal being picked up. (Information gathered from the Communications Specialists website).



*Figure 5.6: The Communications Specialists R-1000 Telemetry receiver. Gathered from the Communications Specialists website.*

### **5.3 Evaluation Criteria**

An interview of Alex Jackson on some aspects of the design were conducted. The first question asked whether the design made sense in which he replied yes. He had input regarding the designs practicality and made it clear that he understood the demand for the product. It was said that he would use this design for the intended purpose and suggested that the plan introduced should be followed through as was presented.

Another interview was conducted with Zach Sharon regarding our initial design. His first thoughts were to use the professors in our department for consulting about interference issues. He also thought we could do some initial tests using some common parts that professors may have in their labs, such as a GoPro and a directional antenna. He specifically mentioned Andy Olson's antenna lab. Zach also pointed out to make sure the design was user friendly and could easily be controlled and flown. He said he would certainly use the design if he were in the ecology field. Zach suggested making sure the parts were easy for anyone to assemble on the quadcopter, and possibly attempting to make them easy to take on and off if need be. As a final suggestion, he



mentioned looking into running the whole design off of a single battery, which would eliminate the need for multiple chargers and sources of power out in the field.

Additionally, a brainstorming session was held with Professor Scott Creel about what might be causing interference. Since a level one requirement is an interference-less design, it is crucial to check each component. One of the possibilities is the carbon fiber propellers. Professor Creel advised to check this theory as soon as possible and plan accordingly.

#### **5.4 Convergence Plan**

Based on the feedback received from Zach, the antenna lab will be utilized to its fullest and Andy Olson will be asked about an optimal way to tackle the interference problem. Additionally the design must be user friendly and provide sufficient documentation, which would allow anyone to use the product. A single battery is a great idea and depending on the available options will be incorporated in the design.

After consulting the sponsor, Scott Creel, there is a possibility that the material propellers are made out of will be changed. This is due to carbon fiber being known for causing interference in the 5.8GHz band. The final decision will be made after conducting additional tests, since carbon fiber is very durable and lightweight and would be optimal for high altitudes and maximum flight time.

#### **5.5 Contingency Plan**

As a backup, several changes would be made to the concept discussed. This alternative design would involve stripping off several components from the system, while still maintaining that the goal of the project has been reached. There are multiple components that certainly add to the design, but are not necessarily essential to the success of the project. One such component is the GoPro. While it is a great addition to have aerial video being transmitted from the quadcopter, it may be found that this additional part causes too much interference. The interference may come from the stabilization system used by the GoPro, or some other source of noise may be found to be emitting from

the device. In either case, the GoPro would be removed and the end goal would still be reached.

Another component that could be stripped off of the final design is the quadcopter's flight stabilization system. This would have to be done if interference was found to be coming from this component and it could not be prevented using other measures. The user would still be able to fly the device without this system, however it would require the user to be much more careful. The conditions in which the quadcopter could be flown would be limited. Without the flight stabilization system, flight would have to be limited to calm conditions. Any wind would severely affect the quadcopter. However, the end goal could still be reached, as the user simply has to take the quadcopter up to flight, find the signal from the collar, and take the quadcopter back down to ground. This is achievable in calm conditions without the flight stabilization system.

## **6 SYSTEM ARCHITECTURE**

### **6.1 Introduction**

This section of the report will explain the system architecture for the wildlife tracking system. All the interfaces will be explained and broken down into mechanical, electrical, wireless, and human interfaces. The design is depicted by a drawing and flow diagram that will depict a visual understanding of the product's operation. The sub-system interfaces will break down the initial flow diagram into more detail. Lastly, the user interfaces are explained. This will entail all the human factors the design considers.

### **6.2 System Architecture Plan**

Figure 6.1 below shows high-level system architecture plan and how various components interface with one another. The schematic is visually divided into 3 groups: Quadcopter, Ground Control and Tracked animal. All of these are equally important to the overall goal of the design. The most important aspect of the design is how the signal from the tracked animal reaches the end-user and all components that support this process. In short: the signal from VHF collar propagates through space and reaches the VHF directional antenna; if the signal is in the main lobe of the antenna, where it is the strongest, the receiver can pick it up and demodulate the audio carried by the signal; afterwards using the 'Audio Out' port on the receiver we modulate the audio onto 5.8GHz carrier (in 5.8GHz transmitter), which then propagates through space and reaches the 5.8GHz receiver, which then demodulates the signal and the audio can be heard in the headphones by the end user. The VHF link between the animal and the quadcopter was chosen due to great propagation characteristics and inexpensive collar trackers. The 5.8GHz link between the quadcopter and the user was chosen due to it being least susceptible to interference from other system components.

The supporting components of the process described above are:

- 1) The quadcopter, which supports the Directional antenna, battery power supply, 5.8GHz Tx and VHF Rx. Due to it being able to fly at significant altitudes, the VHF signal can be heard a greater range.
- 2) The battery power supply #2, which powers the 5.8GHz Tx. The VHF Rx is a handheld receiver which has an internal battery. The quadcopter is powered from the main battery pack #1.
- 3) GoPro camera which feeds video into the 5.8GHz relay and allows the user to see which way the quadcopter is facing and allows easier tracking of the animal.

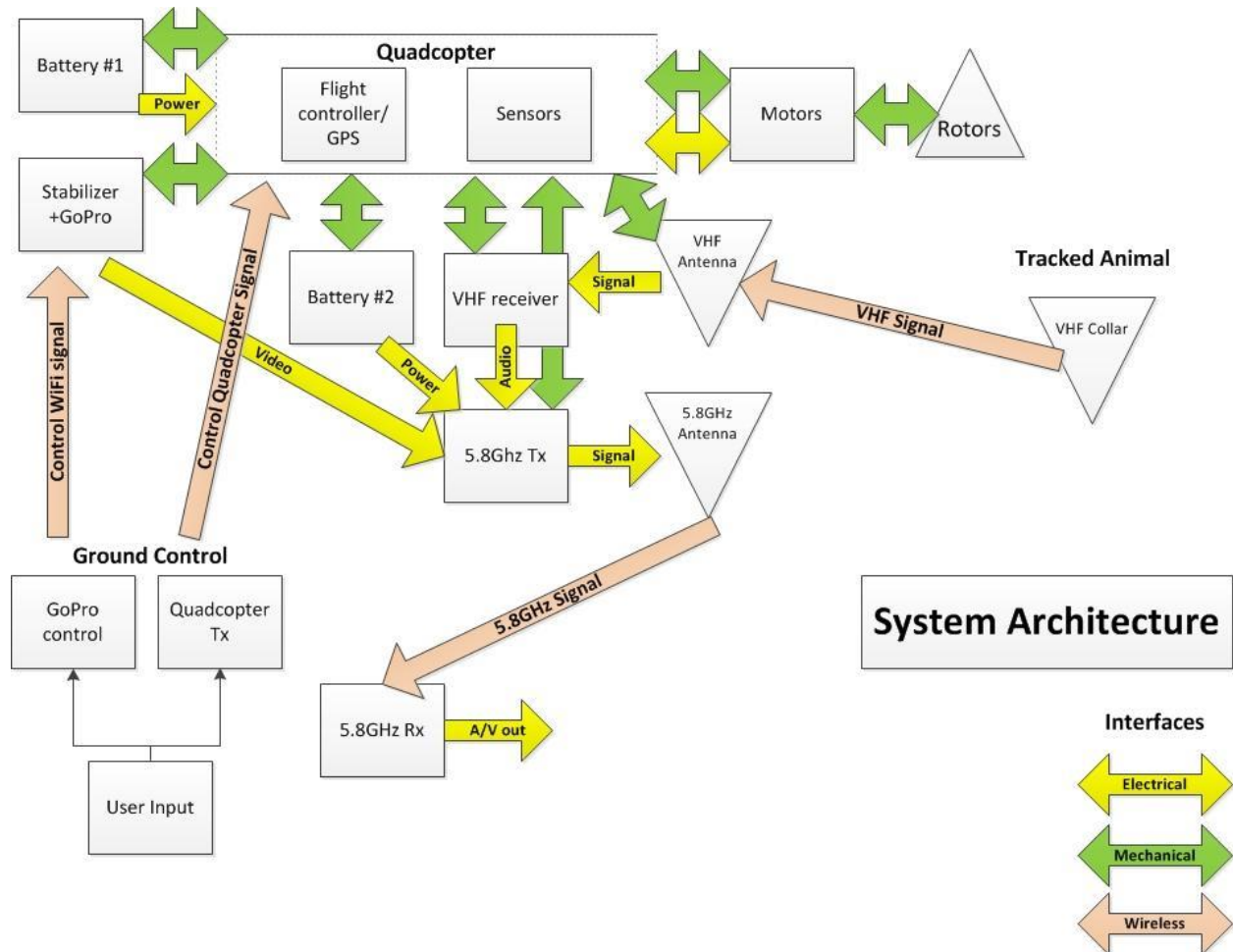

Figure 6.1: High-level system architecture plan

### **Wireless Interfaces:**

- Long distance quadcopter Tx to quadcopter
- VHF collar signal to VHF receiver on the quadcopter
- Wi-Fi GoPro control
- 5.8Ghz link between Tx on the quadcopter and Rx on the ground

### **Mechanical Interfaces:**

- Rotors to motors (screws)
- GoPro attached to the quadcopter through gyro-stabilizer
- 5.8GHz Tx attached to the quadcopter (screws)
- VHF receiver attached to the quadcopter (Velcro)
- H-antenna attached to the quadcopter (Velcro)

### **Electrical Interfaces:**

- 5.8GHz Rx with a 5.8GHz Omni/dipole antenna through a SMA/BNC cable.

Current choices are:

- Duo5800 v3 Diversity A/V Rx (powered on the ground)
  - SpiroNET Omni - 5.8Ghz CP Antenna
  - SMA cable
- 5.8GHz Tx with a 5.8GHz Omni/dipole antenna through a SMA/BNC cable.

Current choices are:

- ImmersionRC 5.8Ghz 600mW A/V Tx
- SpiroNET Omni - 5.8Ghz CP Antenna
- SMA cable

- VHF ( $\sim 150\text{MHz}$ ) Rx with a directional antenna through a BNC cable. Current choices are:
  - H-shaped directional antenna
  - R-1000 telemetry receiver(internal battery powered)
  - BNC cable
- VHF Rx Audio Output to 5.8GHz Tx
  - 5-pin Molex SL audio/video (remove audio wire from GoPro, instead connect to VHF Rx Audio Output)
- GoPro to 5.8GHz Tx
  - 5-pin Molex SL audio/video (remove audio)
- Power Supply to 5.8GHz Tx
  - 2-pin Molex SL, battery input (6-25V DC)
- Quadcopter Matrix S-FPV interfaces (details can be found on the manufacturer website)
  - Battery power supply
  - Flight controller/Multi-rotor stabilization
  - GPS chip
  - Motors
  - Internal electronics

### 6.3 System Interfaces

The system interface can be seen below in Figure 6.2 which is broken down into various colors for each sub-system. Shown in black is the quadcopter system this is the platform that the tracking system will be built upon. In red is the in-flight stabilization system that will auto-pilot the quadcopter in windy conditions and help the pilot controlling the system to have ease of use. Shown in green is the camera stabilization mount and in purple is the camera, though these systems are not essential for animal tracking they will aid in the determination of approach as the animals are located. The VHF receiver and antenna shown in orange will be mounted to the underside of the quadcopter to help prevent interference from other systems and allow maximum line of sight in locating a collar signal. Shown in blue is the 5.8 GHz relay that will transmit the audio and video signals from the quadcopter to the pilot to aid in triangulation. Finally shown in pink is the wireless transmitter that is used in the piloting of the quadcopter.

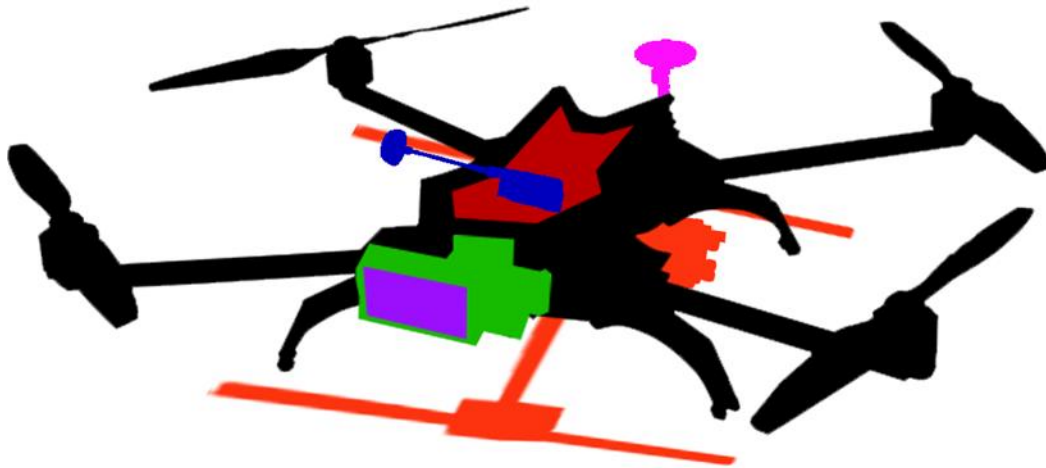

*Figure 6.2: Wildlife tracking system broken into individual sub-systems.*

Figure 6.3 below shows the flow diagram for the wildlife tracking system. The pilot control interface will control the movement of the quadcopter simultaneously with the assistance of the flight stabilization system shown in the flowchart. The camera and VHF receiver will be connected to the 5.8 GHz video and audio relay which will be sent to the pilot on the ground to determine direction and distance to the animal being tracked. It can be seen in the flowchart that the camera is connected to the quadcopter with an auto-stabilization mount which will help balance the video. It can also be seen that the VHF receiver is connected to an H-antenna which are commonly used in the wildlife tracking fields of study.

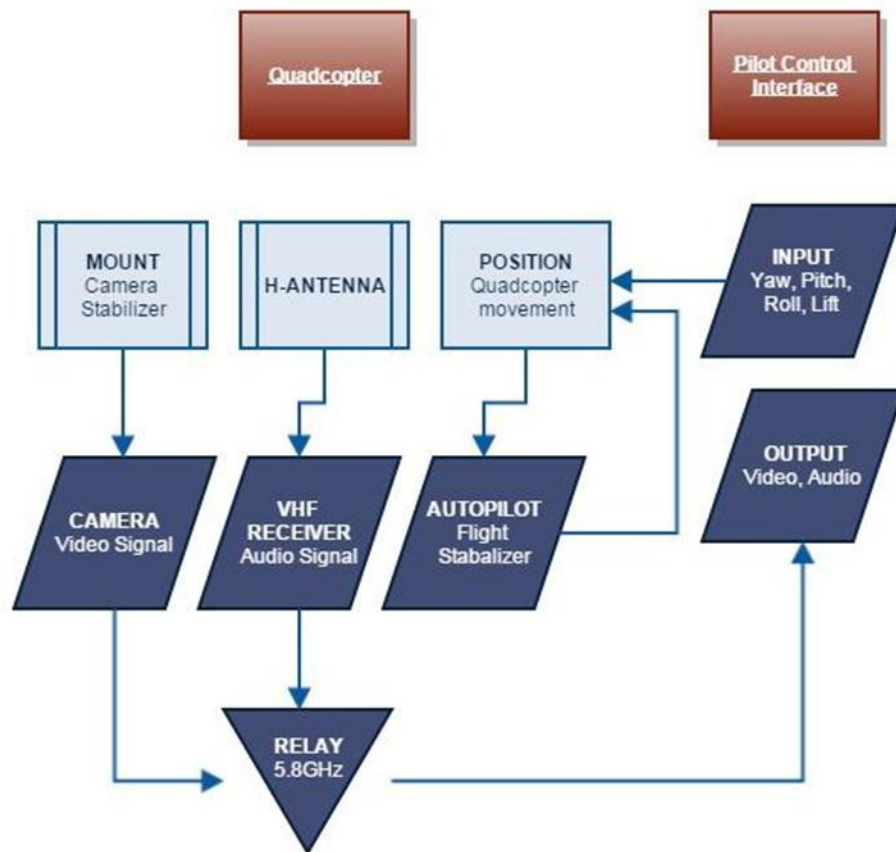

Figure 6.3: The system architecture flowchart for the wildlife tracking system.



## 6.4 Sub-System Interfaces

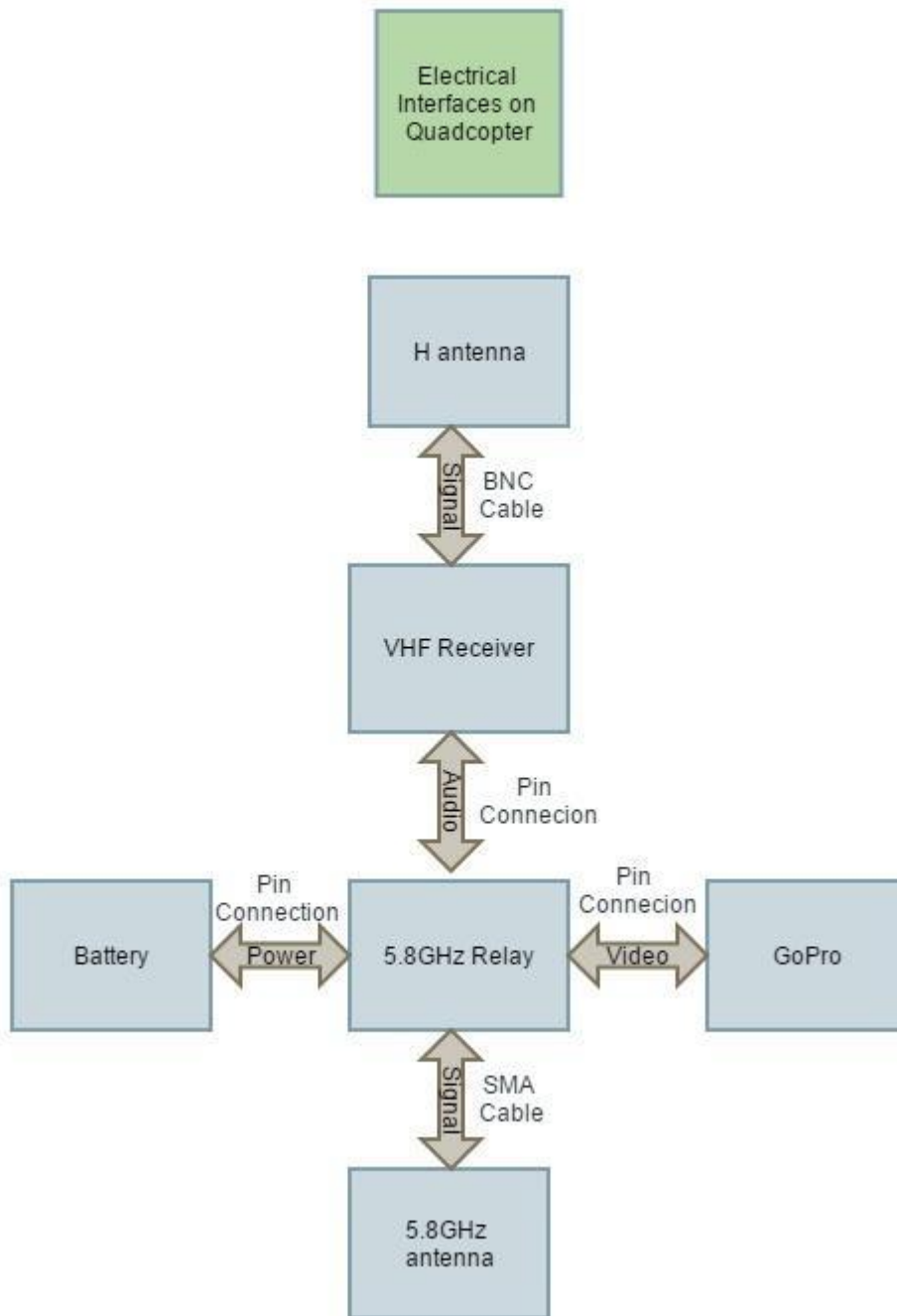
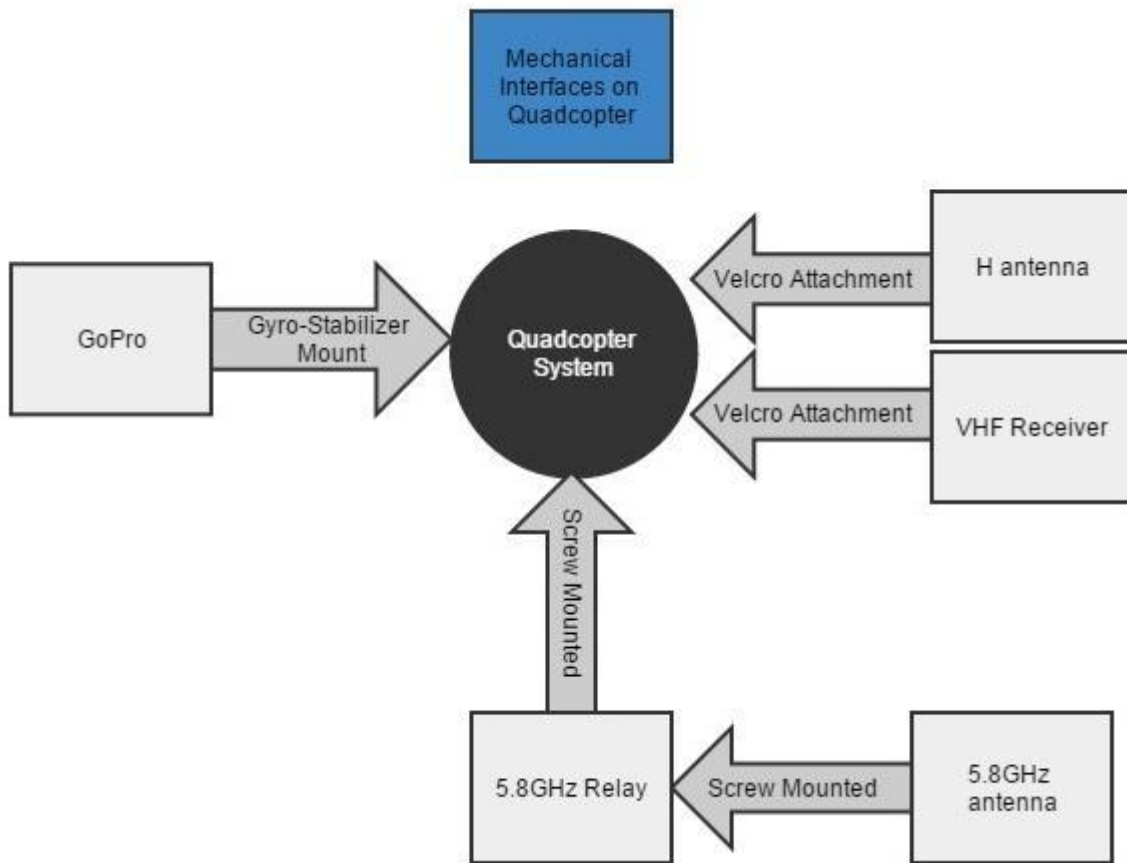

Figure 6.4: Electrical Subsystem Interface for the components on the quadcopter.



*Figure 6.5: Mechanical Subsystem Interfaces for the components on the quadcopter.*

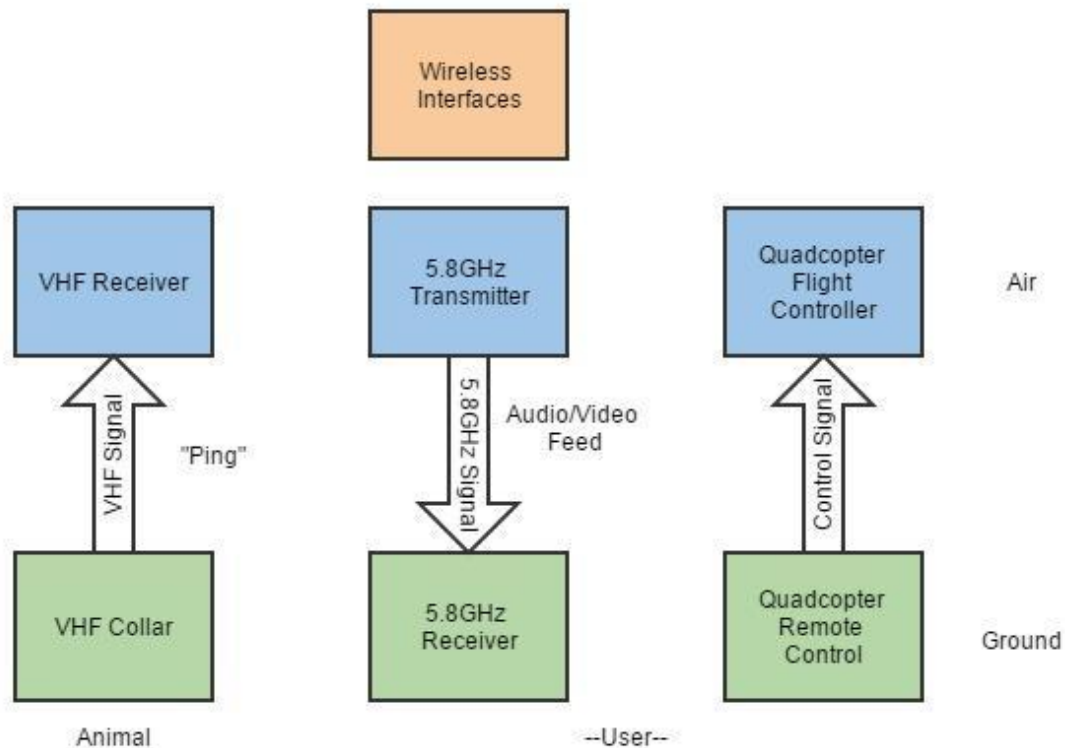

Figure 6.6: Wireless Subsystem Interfaces between components

## 6.5 User Interfaces

The user interfaces will incorporate the human factors the user will have to consider when operating the design. Firstly, the user will have to deploy the assembled quadcopter. This entails taking it out of the designated carrying case, and rearranging the quadcopter from carrying mode to operating mode.

Secondly, the user will have to ensure that all the components' batteries are charged as well as turned on and operating before the quadcopter is powered. The components that correspond to this step are, the 5.8GHz relay, the VHF receiver, the Hero3 GoPro camera, and the directional VHF H-antenna. This step contains a ground test to confirm that the audio and video are being transferred to the user clearly. A test run on the VHF receiver can be conducted by a collar held by the user. The quadcopter's GPS system will

have to be enabled and confirmed that it is operating correctly. The GPS system will enable the quadcopter to return to the user automatically if something goes wrong, or if the quadcopter is not fully charged.

Once the previous steps have been conducted, the user will now operate the quadcopter. This entails a controller the user will handle, as well as an audio/video feed that the user can see on the ground transmitted from the quadcopter. The user will be able to control the quadcopter's elevation and bearing. The user will not have to compensate for an unexpected gust of wind that knocks the quadcopter off kilter since the GPS stabilization device will do this automatically for the user.

Finally, to fulfill the purpose of the design, the user will rotate the quadcopter at its operational height. The quadcopter will be rotated until an audible "beep" is heard on the A/V feed. This "beep" correlates to a collar. Therefore, the user will have a bearing on the direction of where the animal is located. With the elevation of the quadcopter at which the "beep" was heard, the user will be able to figure out the distance of the location of the animal. Indubitably, the location and bearing of the animal is achieved. After all is done, the user will have to land the quadcopter, power down the components, and stow away the quadcopter into its designated carrying case.

## 7 DETAILED DESIGN

### 7.1 Introduction

In the detailed design, everything that is required to build the model is described. Layout drawings, dimensions, and specifications are included for each part in the system. These details have been obtained from the manufacturers. Additionally, a bill of materials has been created, listing each essential part. Necessary calculations for the final design are also included at this point. These include weight, battery, and distance considerations. A full model is displayed, showing each component fitting together on the quadcopter. Safety considerations are also discussed, and finally the product lifecycle is described in detail.

### 7.2 Layout Drawings

Turbo Ace Matrix-S-FPV:



*Figure 7.1: The Matrix S-FPV. Gathered from the TurboAce website.*

- Dimensions Wingspan (including propellers): Diagonal=1110mm, Front=1000mm, Back=935mm
- Dimensions Operating Position (including propellers): W=760mm, L=760mm, H=130mm

- Wind Tolerance: Class 5  
(Information for the quadcopter from turboace.com Matrix S-FPV overview).

5.8GHz 600mW Tx Relay:



Figure 7.2: The 5.8GHz relay

- Dimensions (LxWxH): L=50mm x W=23mm x H=15mm
- Weight (Grams): 18g
- Supply Voltage: 6-25V (2S-6S LiPo)
- Power Consumption: 3W  
(Information from ImmersionRC.com)

Duo5800 v3 Diversity A/V Rx Link:



Figure 7.3: The 5.8 GHz Link

- Dimensions (LxWxH): L=88mm x W=105mm x H=25mm
- Weight (Grams): 202g
- Located on ground-not on quadcopter  
(Information from ImmersionRC.com)

R-1000 TELEMETRY RECEIVER:



*Figure 7.4: The VHF receiver*

- Dimensions: 6.1" (15.5cm) high, 2.6" (6.6cm) wide, 1.5" (3.8cm)
  - Weight: 12.4oz. (352 g)
- (Information from R-1000 TELEMETRY RECEIVER OPERATING MANUAL)*

Black Velcro Cable:



*Figure 7.5: The Velcro straps for the VHF receiver*

- Unit Weight: 0.30 lbs
  - Size: 3/4 x 12"
- (Information from ULINE)*

Hosa BNC to BNC Cable:



*Figure 7.6: BNC cable for VHF Receiver to antenna*

- Weight: 4.8 oz
- Length 3'  
(Information from Sweetwater)

SMA Male on RG58C/U to SMA Female Bulkhead Cable:

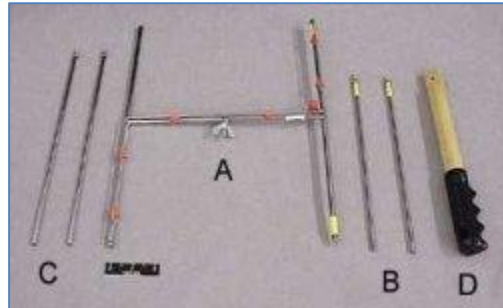

*Figure 7.7: SMA cable for 5.8 GHz link*

- Operating Temperature: 80 °C
- Length: 1'  
(Information from fieldcomponents.com)



RA-2AK VHF Antenna:



*Figure 7.8: The VHF Antenna*

- Length: 1.5'
- Width: 3'  
(Information from Telonics.com)

### 7.3 Bill of Materials

Figure 7.9 shows the flow diagram for the components (1-6) which create subsystems (7-9) and finally with all subsystems built and interfacing on the quadcopter the final design (10) is realized. Table 7.1 shows a break down each device cost organized by subsystem.

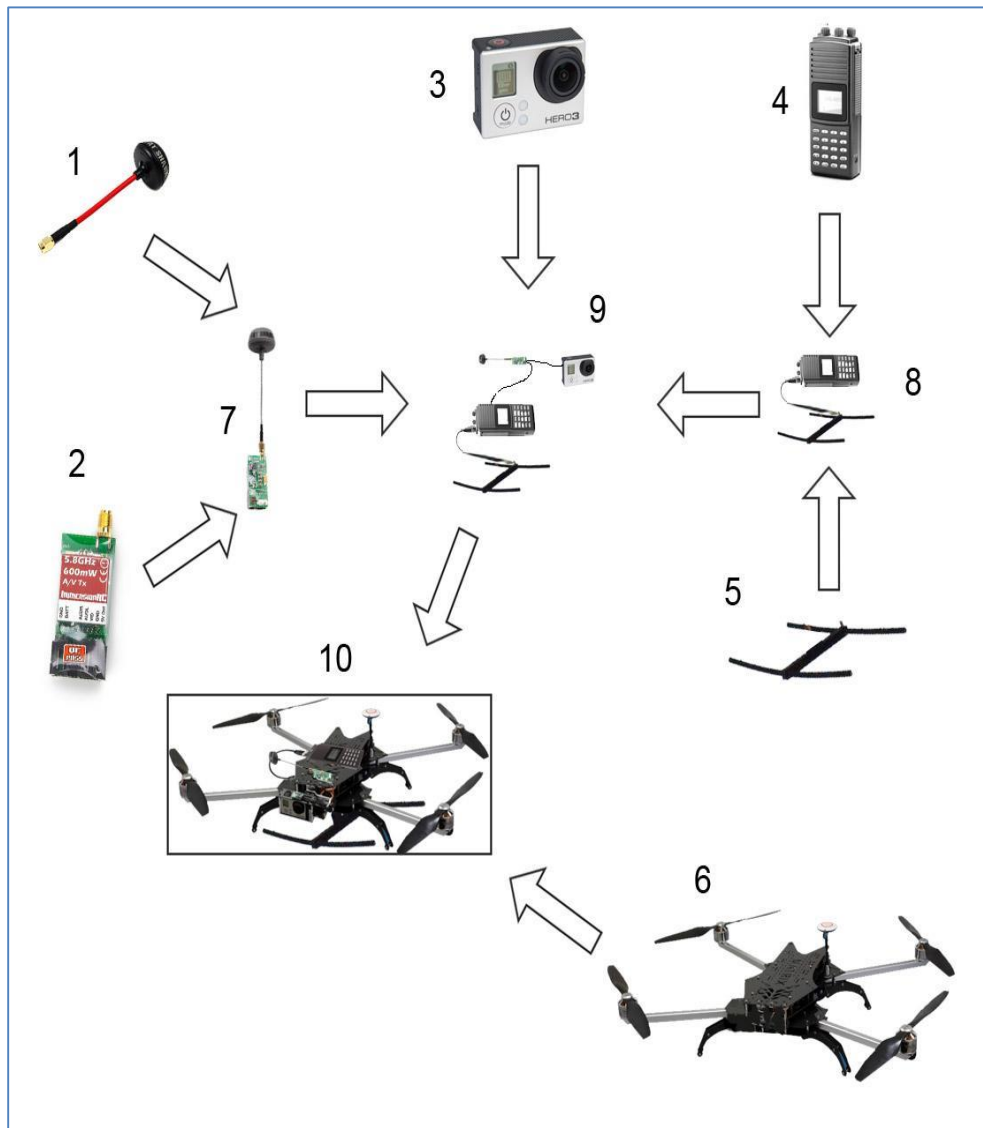

Figure 7.9: Flow diagram showing all of the individual parts, subsystems and final design.

Table 7.1: Cost analysis for the wildlife tracking system

10	<b>Wildlife Tracking System</b>	
9	<b>Video/Audio Relay Subsystem</b>	
8	<b>VHF Subsystem</b>	
4	R-1000 TELEMETRY RECEIVER	\$695.00
5	RA-2AK VHF Antenna	\$50.00
	Hosa BNC to BNC Cable	\$6.99
7	<b>Relay Subsystem</b>	
1	SpiroNET Omni - 5.8GHz CP Antenna	\$39.99
2	5.8GHz 600mW Tx Relay	\$69.00
	SMA Male on RG58C/U to SMA Female Bulkhead Cable:	\$30.74
3	GoPro Hero 3 Camera	\$399.99
6	Turbo Ace Matrix-S-FPV	\$3,847.95
	<b>Ground System (not pictured)</b>	
	Duo5800 Diversity A/V Rx	\$239.00
	Total Cost	\$5,378.66

## 7.4 Purchased Component Specifications

### Turbo Ace Matrix-S-FPV Specifications:

- Dimensions Wingspan (including propellers): Diagonal=1110mm, Front=1000mm, Back=935mm
- Dimensions Operating Position (including propellers): W=760mm, L=760mm, H=130mm
- Dimensions Folded Position (including propellers): W=295mm, L=780mm, H=110mm
- Dimensions Motor to Motor: Diagonal=725mm
- Maximum Payload Capacity: Gimbal + Camera + Accessories = 3.5LB, Gimbal+Camera+Accessories+8000mah Battery=6.2LB
- Maximum Optimal Payload Capacity: Gimbal + Camera + Accessories = 2.5LB, Gimbal+Camera+Accessories+8000mah Battery=5.2LB
- Matrix Weight without Payload/Battery: 4.8LB
- Typical Operating Weight with Hero3: Matrix+Gyrox-3+VTX& Power (5.33LB)+ Hero3 (.17LB) +VTX+8,000mah Battery (2.5LB) = 8LB
- Typical Operating Weight with Sony NEX 5R: Matrix-E+Gyrox-5R+VTX&Power (5.5LB) + NEX-5R+Lense (1LB), 8,000mah Battery (2.5LB) = Total: 10LB
- Motors: Diameter=42mm, Height=35mm

- ESC: 40 amp
- Propellers: 2xCW & 2xCCW, 15" Extra Robust Carbon Fiber Constructions, Dual Position Mount
- Flight Time: Matrix + 22,000mah 6S Battery + Brushless Gyrox-3 Gimbal + Hero 3/3+ = 40-42 min
- Flight Time: Matrix + 2x 10,000mah 6S Battery + Brushless Gyrox-3 Gimbal + Hero 3/3+ = 38-40 min
- Flight Time: Matrix + 16,000mah 6S Battery + Brushless Gyrox-3 Gimbal + Hero 3/3+ = 36-38 min
- Flight Time: Matrix + 10,000mah 6S Battery + Brushless Gyrox-3 Gimbal + Hero 3/3+ = 26-29 min
- Flight Time: Matrix + 8,000mah 6S Battery + Vibration Isolation Carbon Plates + Hero 3/3+ = 27-30 min
- Flight Time: Matrix-S + 8,000mah 6S Battery + Brushless Gyrox-3 Gimbal + Hero 3/3+ = 22-25 min
- Flight Time: Matrix-E + 8,000mah 6S Battery + Brushless Gyrox-5R Gimbal & Sony NEX-5R = 12-15 min
- Transmitter & Receiver Recommendation: 2.4GHz, Minimum 6-Channels, Optimal 7-Channels or more
- Standard Distance Operations: 300 to 500 feet (Using Walkera Devo 10 & Most Other Name Brand Transmitters)
- Long Distance Operations: 4,224 feet (.8miles) to 6,336 feet (1.2miles) (Using Spektrum DX8/DX18 & Futaba 14SG)
- FPV Recommendation: 5.8GHz Video Transmitter & Video Receiver + Monitor or Goggles
- Wind Tolerance: Class 5
- Aluminum Case Dimensions: L=935mm, W=410mm, H=145mm  
(*Information for the quadcopter came from turboace.com Matrix S-FPV overview*).

#### 5.8GHz 600mW Tx Relay:

- 600mW (27dBm, +/- 1dBm) of clean output power
- SMA Antenna connector, with supplied 5.8GHz Rubber-duck antenna
- Frequencies: 5740, 5760, 5780, 5800, 5820, 5840, 5860MHz
- Not affected by 2.4GHz R/C radios
- Dimensions (LxWxH): L=50mm x W=23mm x H=15mm
- Weight (Grams): 18g
- Supply Voltage: 6-25V (2S-6S LiPo)
- Power Consumption: 3W  
(*Information from ImmersionRC.com*)

Duo5800 v3 Diversity A/V Rx Link:

- A/V receiver with diversity antenna inputs
- GS-Link for single-cable connection to a groundstation
- Frequencies: 5740, 5760, 5780, 5800, 5820, 5840, 5860MHz
- NexWaveRF technology, for double-range
- Not affected by 2.4GHz, or UHF R/C radios
- Dimensions (LxWxH): L=88mm x W=105mm x H=25mm
- Weight (Grams): 202g  
(*Information from ImmersionRC.com*)

R-1000 TELEMETRY RECEIVER:

- Selectivity: 6dB down @  $\pm 1.2$  kHz, 60dB down @  $\pm 2.2$  kHz
- Receive Mode: CW
- Antenna Impedance: 50 ohms
- Antenna Jack: Standard BNC (BNC female)
- Power Requirements: 4.8vdc (4 ea. "AA" Ni-cad or NiMH rechargeable batteries), or 6.0vdc (4 ea. "AA" Alkaline batteries), or 9-16vdc from supplied 110vac wall or cigarette lighter charger
- Current Drain: 160ma at maximum audio output
- Dimensions: 6.1" (15.5cm) high, 2.6" (6.6cm) wide, 1.5" (3.8cm) deep, less knobs
- Weight: 12.4oz. (352 g) with supplied NiMH rechargeable batteries
- Headphone Jack: Top Mounted 3.5mm (1/8") mono headphone jack  
(*Information from R-1000 TELEMETRY RECEIVER OPERATING MANUAL*)

Black Velcro Cable Ties:

- Dimensions: Width- Slotted End: 3/4" Narrow End: 1/2"
- Material: Polypropylene hook, Nylon loop  
(*Information from ULINE*)

Hosa BNC to BNC Cable:

- Type: Video/Word Clock
- Connector: Male BNC to Male BNC
- Length: 3'  
(*Information from Sweetwater*)

SMA Male on RG58C/U to SMA Female Bulkhead Cable:

- RG Type:58C/U
- Conductor: 20 AWG 19/32 Tinned Copper
- Insulation: Solid Polyethylene

- Nom. Core O.D.: 0.115 in
  - Shielding: Tinned Copper
  - Jacket: Non-Contaminating PVC -Type 11A
  - Nom. O.D.: 0.199 in
  - UL Style: 1354
  - Nom. Attenuation:
    - 1.4 db/100 ft at 10 MHz
    - 4.1 db/100 ft at 50 MHz
    - 5.3 db/100 ft at 100 MHz
    - 8.2 db/100 ft at 200 MHz
    - 12.6 db/100 ft at 400 MHz
    - 20.0 db/100 ft at 900 MHz
    - 24.0 db/100 ft at 1000 MHz
  - Nom. Velocity of Propagation: 83%
  - Nominal Capacitance: 16.2 pF/ft
  - Nominal Impedance: 50 ohms
  - Operating Temperature: 80 °C
  - Frequency: 1ghz
- (Information from fieldcomponents.com)*

RA-2AK VHF Antenna:

- Frequency Ranges: 148-152 MHz, 150-154 MHz, 158-162 MHz, 164-168 MHz, 168-172 MHz, 170-174 MHz, 216-220 MHz
- Gain: 4 dBd
- Front to Back Ratio: 10 dB
- Connector: BNC female
- Reception Radiation Pattern:

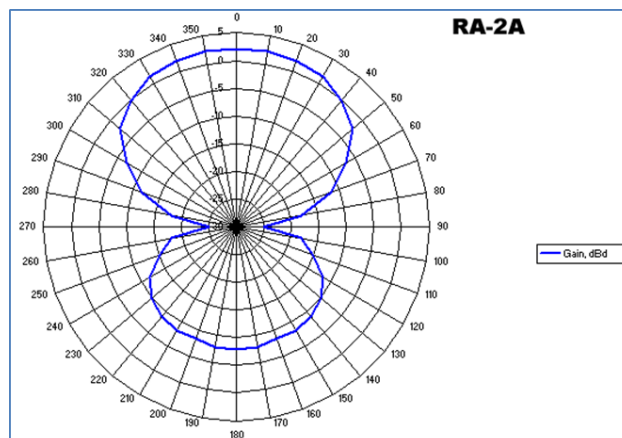

*(Information from Telonics.com)*

## 7.5 Detailed Design

### 7.5.1 Calculations

The following images show calculations conducted in order to verify that level 1 requirements are theoretically satisfied. These calculations are preliminary, final calculations will be done in Mathcad.

Level 1 requirements verified:

- Tracking distance above 2km
- Maximum payload weight 6.2LB
- Flight time equal or above 30 minutes

7

Performance calculations:

Weight (Payload max 6.2LB optimal 5.2LB)

Battery: Bigger battery → Longer flight

	kg	LB
- 8000 mAh	1.111	2.449 (current choice)
- 16000 mAh	1.933	4.257
- 10000 mAh	1.355	2.994

VHF Rx:

- R-1000	0.352	0.776
----------	-------	-------

5.8GHz Tx:

- 600mW Tx	0.018	0.0397
- SparkNet Ant	0.012	0.0264

Directional Ant:

- RA-2K VHF	maximum worstcase 0.5kg	1.1
-------------	-------------------------------	-----

Miscellaneous

- Velcro x 4	0.504	
- BNC cable 3'	0.816	0.3 x 3
- SMA cable 1'	0.172	0.09 x 3
	0.018	0.04

★ Total Payload Weight:

	kg	LB
	2.677	5.9

0.3LB under maximum payload weight

Figure 7.10: Payload weight calculations.

Information for the H-directional antenna weight could not be obtained. Worst case scenario, if it weighs 1.1 LB, overall weight is 5.9LB which is 0.3 less than the maximum limit.



### >>> Battery Life:

From quadcopter manufacturer website

VHF Rx: 12hr life | Flighttime is specced at 27-30 min

Since 5.8GHz Tx and VHF Rx have separate batteries, they do not influence the flight time.

### >>> VHF signal reception range (theoretical)

- VHF Rx:
  - > sensitivity  $-118 - 150 \text{ dBm}$  (minimum signal strength that can be heard)
  - > max RF gain  $80 \text{ dB}$  (going to be on max all the time)

- VHF collar Tx:

$$P_{tx} = 15 \text{ mW} = 11.76 \text{ dBm}$$

- RA-2AK antenna:

$$\text{Gain} = 4 \text{ dBd} = 6.1 \text{ dBi}$$

- BNC cable loss:  $4 \text{ dB} / 100 \text{ feet} \dots$  negligible  $= 0.12 \text{ dB}$   
 $\times \frac{3 \text{ ft}}{100 \text{ ft}} = \frac{3 \text{ dB}}{100}$

### ★ Multipath/Reflection model

$$\text{in dB: } P_r = P_t + G_t + G_r + 20 \log(h_{tx}) + 20 \log(h_{rx}) - L_{\text{sys}} - 40 \log(d)$$

$\nwarrow$  Rx power     $\nearrow$  Tx power     $\nearrow$  Tx gain     $\nearrow$  Tx height     $\nearrow$  Rx height     $\nwarrow$  cable loss     $\nwarrow$  propagation distance

$$\text{Assume average } h_{rx} = 1000 \text{ ft} = 304.8 \text{ m}$$

$$h_{tx} = 0.5 \text{ m}$$

$$\text{best case } P_r = -150 \text{ dBm}$$

Figure 7.11: Battery life calculations were unnecessary since VHF/5.8GHz radios are independently powered. Signal reception range calculations.

The quadcopter manufacturer provides information on average flight time based on the payload weight. For this design's payload, the flight time is 27-30 min, which is very close to the requirement of 30 min. Signal reception range calculations are also included here.

9

multipath model calc. continued...

$$40 \log(d) = P_t - P_r + G_t + G_r - L_{\text{sys}} + 20 \log(h_{tx}) + 20 \log(h_{rx}) =$$

$$= 11.8 + 150 + 0 + 6.1 + 20 \log(0.5m) + 20 \log(300m) =$$

$$= 211.4 \text{ dB}$$

$$d = 10^{\frac{211.4}{40}} = 158489 \text{ m} = \boxed{158 \text{ km}}$$

Obviously this model is <sup>not</sup> suitable for the scenario where the receiver is high up in the air and it does not account for clutter.

★ Hata model (suitable for open/rural areas) Tx height @ 200m

$$L = 28.61 + 44.5 \log(f_o) - 4.78 (\log f_o)^2 - 13.82 \log h_{tx}$$

$$+ (44.9 - 6.55 \log h_{tx}) \log(d) + 0.8$$

$$29.8 \log(d) + 70.2 = 11.8 + 150 + 6.1$$

$$\boxed{d = 1896.7 \text{ km}}$$

this is a realistic number and ~~that~~ model is not suitable because Tx is at 200m and not at 200m Rx is at 300m and not at 1m

Need to use a more sophisticated algorithm that accounts for clutter, and works with our parameters.

Langley - Rice model online calculator available

Figure 7.12: Signal reception range calculations continued.

The Multipath/reflection model is not suitable since it does not account for clutter. The Hata model is not suitable since it assumes the Tx is higher than the Rx. It is the opposite in this case. It was recommended to use the Longley-Rice model for this design. This model accounts for clutter and works for various Rx/Tx heights. The calculations were done in an online calculator, since the algorithm is too sophisticated to be done on paper.

### Radio Coverage Prediction using Longley Rice

Transmitter			
Latitude:	<input type="text" value="12"/> ° <input type="text" value="47"/> ' <input type="text" value="6.1"/> "	<input type="text" value="South"/>	Antenna Pattern (Horiz. Plane) 0 4 10 4 20 3 30 1 40 0 50 -3 60 -8 70 -12 80 -18 90 -25 100 -18 110 -15 120 -12 130 -10 140 -8 <input type="button" value="Details"/>
Longitude:	<input type="text" value="31"/> ° <input type="text" value="39"/> ' <input type="text" value="11.7"/> "	<input type="text" value="East"/>	
<small>Note: the transmitter position can also be set using the "Set Tx Pos" button below.</small>			
Height Above Ground (m):	<input type="text" value="0.5"/>	(0.5 - 3000 m)	
Frequency (MHz):	<input type="text" value="150.0"/>	(20 - 40000 MHz)	
Power (W):	<input type="text" value="0.015"/>		
Polarization:	<input type="text" value="Horizontal"/>		
Antenna Gain (dBi):	<input type="text" value="2"/>		
Antenna Pointing Azimuth (°):	<input type="text" value="0"/>	(0° - 359.9°; North = 0°)	
Propagation Model: Longley Rice (Point-to-Point)			
Surface Refractivity (N-units):	<input type="text" value="301"/>	<input type="button" value="Show List"/>	(250 - 400 N-units)
Dielectric Constant of Ground:	<input type="text" value="15"/>	<input type="button" value="Show List"/>	(4 - 81)
Conductivity of Ground (Siemens/m):	<input type="text" value="0.005"/>	<input type="button" value="Show List"/>	(0.001 - 5.0 S/m)
Climatic Zone:	<input type="text" value="Continental Subtropical"/>		
Confidence Level (%):	<input type="text" value="50"/>	(1 - 99 %)	
Time Availability (%):	<input type="text" value="50"/>	(1 - 99 %)	
Location Availability (%):	<input type="text" value="50"/>	(1 - 99 %)	
Receiver			
Antenna Height Above Ground (m):	<input type="text" value="300"/>	(0.5 - 3000 m)	
Reception Area			
Lower Left Corner Position (decimal degrees):	Latitude <input type="text" value="-13.0166"/>	Longitude <input type="text" value="31.54889"/>	
Upper Right Corner Position (decimal degrees):	Latitude <input type="text" value="-12.73144"/>	Longitude <input type="text" value="31.85788"/>	
<small>Note: the reception area can also be set using the "Set Rx Area" button below.</small>			
Coverage Display			
<input type="checkbox"/>	<input type="text" value="0"/> dB $\mu$ V/m	<input type="text" value="30"/> dB $\mu$ V/m	<input type="text" value="Light Blue"/>
<input checked="" type="checkbox"/>	<input type="text" value="45"/> dB $\mu$ V/m	<input type="text" value="80"/> dB $\mu$ V/m	<input type="text" value="Blue"/>
<input type="checkbox"/>	<input type="text" value="-18"/> dB $\mu$ V/m	<input type="text" value="7"/> dB $\mu$ V/m	<input type="text" value="Dark Blue"/>
<input type="button" value="Set Tx Pos"/> <input type="button" value="Set Rx Area"/> <input type="button" value="Generate Coverage"/> <input type="button" value="Complete"/>			

Figure 7.13: Parameters chosen for the calculations.

Unfortunately the tool is not flexible enough to estimate maximum range, but it provides a propagation map instead.

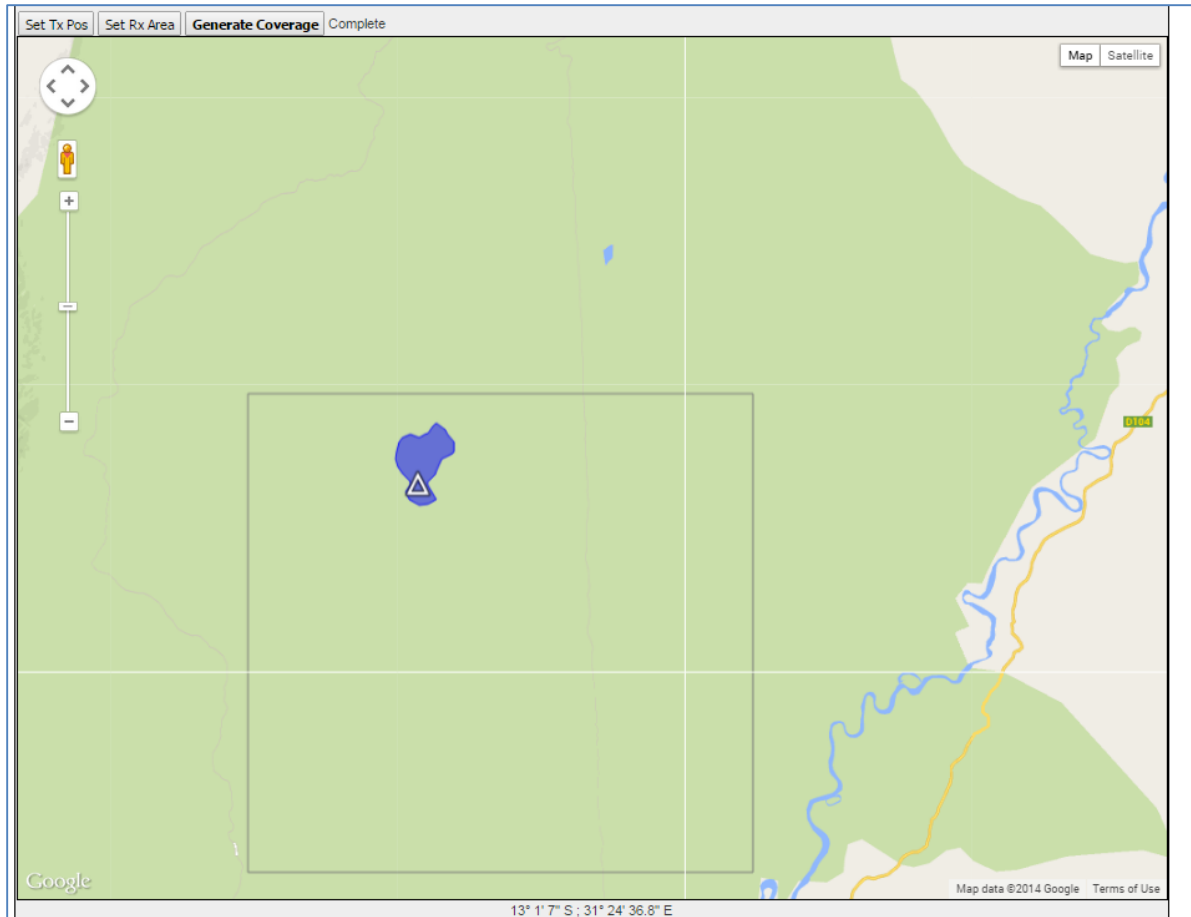

*Figure 7.14: Shows the area that can be picked up by the directional antenna if the signal was coming from the triangle on the map.*

The location was chosen as Zambian National Park (most of the research is done in Zambia). The maximum distance (directional antenna has to point head on at the Tx) was estimated at 2.5 miles (4km) using Google maps. This is twice the range required.

#### Calculations Summary:

Theoretically the system satisfies level 1 requirement and even greatly surpasses in regards of signal detection range. However RF propagation is very sensitive and may vary greatly due to small disturbances. If possible, field tests will have to be conducted at similar or close to similar research conditions in order to test the performance of the system.

## 7.5.2 System Model



*Figure 7.15: Showing each individual part connected in the final configuration.*

It can be seen in Figure 7.15 how the final design will look. The radio and antenna will be mounted at center mass above and below the quadcopter respectively to prevent flight issues that may be caused by adding the additional hardware. The A/V transmitter that will connect the antenna and video to the pilot will be mounted such that any signal interference with the control antenna and VHF antenna will be minimized. This will be connected to both the camera and radio outputs using a shielded SMA Cable also to prevent noise in the signal. Each device will be connected using Velcro so that they may be removed for storage and transportation.

## 7.5.3 Safety Considerations

There are a couple safety considerations that must be taken into account in this design. These safety concerns will be better understood once testing can be performed on the prototype. The first concern is the quadcopter blades. It may be necessary to include additional protection or shielding for these blades, but this is unlikely. Once the quadcopter is obtained, it can be determined whether or not this is a true concern. The second safety consideration will be unwanted RF frequency emission from the design. Again,

once a prototype is built, this can be tested. It is unlikely that this will be a concern, but it should certainly be taken into consideration and fixed if found necessary. Other safety issues may be found during testing, but it is difficult to foresee many concerns at this point.

## **7.6 Product Lifecycle**

This product will begin in the development stage, then continue into a utilization and support stage and finally a decline stage. This group will spend basically all its time in the first stage, while the product will be in the hands of the client and users during the remaining stages.

In the development stage, all of the initial work to get the wildlife tracking system operational will be completed. This includes the preliminary design processes and background research. After this is complete, detailed design can be done, followed by a prototype model being built. Testing and revisions will be done on the prototype, at which point the final product construction can be completed.

In the utilization and support stage, the wildlife tracking system will be in the hands of the client and other users. The user will learn how to operate this system and utilize it in an effective and efficient manner. The user may or may not perform modifications to the design, based on individual preferences or ongoing improvements to the tracking process. The quadcopter design will be able to withstand countless iterations of being taken up into flight to track an animal. However, some maintenance will have to be periodically done on the product. Specifically, the quadcopter battery will need to be recharged after it is used. Other maintenance will include keeping the quadcopter clean, safe, and in good flying condition. Special care will have to be given to keep the blades, antennas, and other essential components free from damage.

The decline stage will be where the product is no longer effective. This may be due to a variety of reasons. Some component of the quadcopter design itself may fail after an extended life of usage. A solution to this would be to purchase a new quadcopter or defective part. The remainder of the good parts could be recycled and reused. The product would then re-enter the utilization

and support stage after reassembly. A cheaper and better solution could also be developed sometime in the future, such as if GPS collars were made to be much less expensive than currently. This would deem the old VHF collars as obsolete, and the quadcopter solution would most likely be retired. In this case, the quadcopter and other components could still be recycled and used for other purposes.

## 8 REFERENCES

Quadcopter

<[http://www.turboace.com/matrix\\_quadcopter.aspx](http://www.turboace.com/matrix_quadcopter.aspx)>

Transmitter

<[http://www.immersionrc.com/product-details.php?fpv\\_product=13&fpv\\_product\\_name=5.8GHz%20600mW%20Tx](http://www.immersionrc.com/product-details.php?fpv_product=13&fpv_product_name=5.8GHz%20600mW%20Tx)>

Receiver Link

<[http://www.immersionrc.com/product-details.php?fpv\\_product=14&fpv\\_product\\_name=Duo5800%20v3%20Diversity%20A/V%20Rx](http://www.immersionrc.com/product-details.php?fpv_product=14&fpv_product_name=Duo5800%20v3%20Diversity%20A/V%20Rx)>

VHF Receiver

<<http://www.com-spec.com/r1000/home.html>>

VHF Collars and Antenna

<[http://www.telonics.com/products/vhfStandard/mammals\\_MedToSm.php](http://www.telonics.com/products/vhfStandard/mammals_MedToSm.php)>

GoPro

<<http://shop.gopro.com/cameras/hero3-white/CHDHE-302-master.html>>

BNC Cable

<<http://www.sweetwater.com/store/detail/BNC103?adpos=1o2&creative=54989267161&device=c&matchtype=&network=g&gclid=Cj0KEQiAwPCjBRDZp9LWno3p7rEBEiQAGj3KJrvT0BnIM7HXSyVCd0MH3RCUXeAX48jne2P0MrUkgTwaAomv8P8HAQ>>

SMA Cable

<[http://fieldcomponents.com/RG58\\_Cable\\_Assemblies.html](http://fieldcomponents.com/RG58_Cable_Assemblies.html)>

Velcro Straps

<[http://www.uline.com/BL\\_6444/Uline-Self-Grip-Straps](http://www.uline.com/BL_6444/Uline-Self-Grip-Straps)>